



*Narrative*  
OFFICE SEATING

Every Chair Tells a Story.

# Contents



*ILY 3-14*



*Well B14-22*



*NV 23-34 -*



*UX 35-44*



*Exemplar 45-54*



*Narrative*  
OFFICE SEATING



# Narrative

## OFFICE SEATING

### Welcome to Narrative Seating

Every Chair Tells a Story.

At Narrative Seating, we believe that a chair is more than just a place to sit - it's where ideas are born, deals are made, and days are shaped. Designed with purpose and crafted for comfort, our office chairs are built to support the stories that unfold in modern workspaces - whether it's the quiet focus of solo work or the energy of team collaboration.

Each design is a thoughtful blend of ergonomics, aesthetics, and durability - because your workspace deserves furniture that not only performs but inspires. With every curve, stitch, and structure, our chairs embody the narratives of innovation, ambition, and progress.

**Take a seat. Start your story.**



# ILY

Our story begins with the ILY Chair - a thoughtfully crafted seat that strikes a balance between comfort, elegance, and everyday performance.

Designed for those who value both form and function, the ILY chair is crafted with meticulous attention to every detail. Its flexible nylon backrest, luxuriously upholstered in premium fabric, gently responds to your movements, enabling prolonged sitting without discomfort or fatigue.

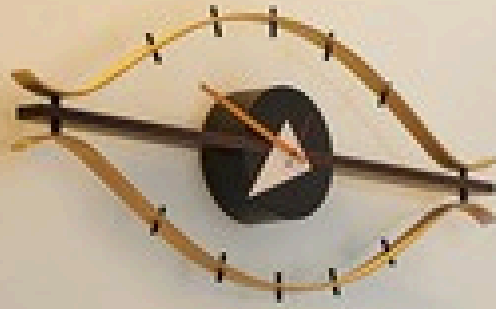

# ILY

## Adaptive Design. Enduring Comfort.

The ILY Chair features 3D lumbar support and 4D adjustable armrests with soft PU pads for personalised comfort. Upholstered in elegant Gabriel Mozart fabric, the seat is layered with high-resilience moulded foam for lasting support.

A synchronised mechanism with four locking positions, seat depth adjustment, and an optional headrest offer dynamic control and a customised fit.

Designed with purpose, ILY brings ergonomic performance into a sleek, refined form.

### Guarantee

- 10-year guarantee on parts.
- 5-year guarantee on fabric.





The ILY Chair combines precision detailing with responsive comfort. Its flexible nylon backrest, wrapped in premium fabric, adapts to your movement - supporting long hours of sitting without strain or fatigue.



## FEATURES

- Upholstered in luxury fabric Flexible design for
- added comfort 3D adjustable lumbar support
- 4D adjustable armrests with PU pads Seat with
- moulded foam cushioning 4-position synchro
- mechanism & seat slide Optional height-
- adjustable headrest Wave Spring System -
- seat cushion suspension BIFMA and
- GreenGuard certified

## DIMENSIONS



# FEATURES

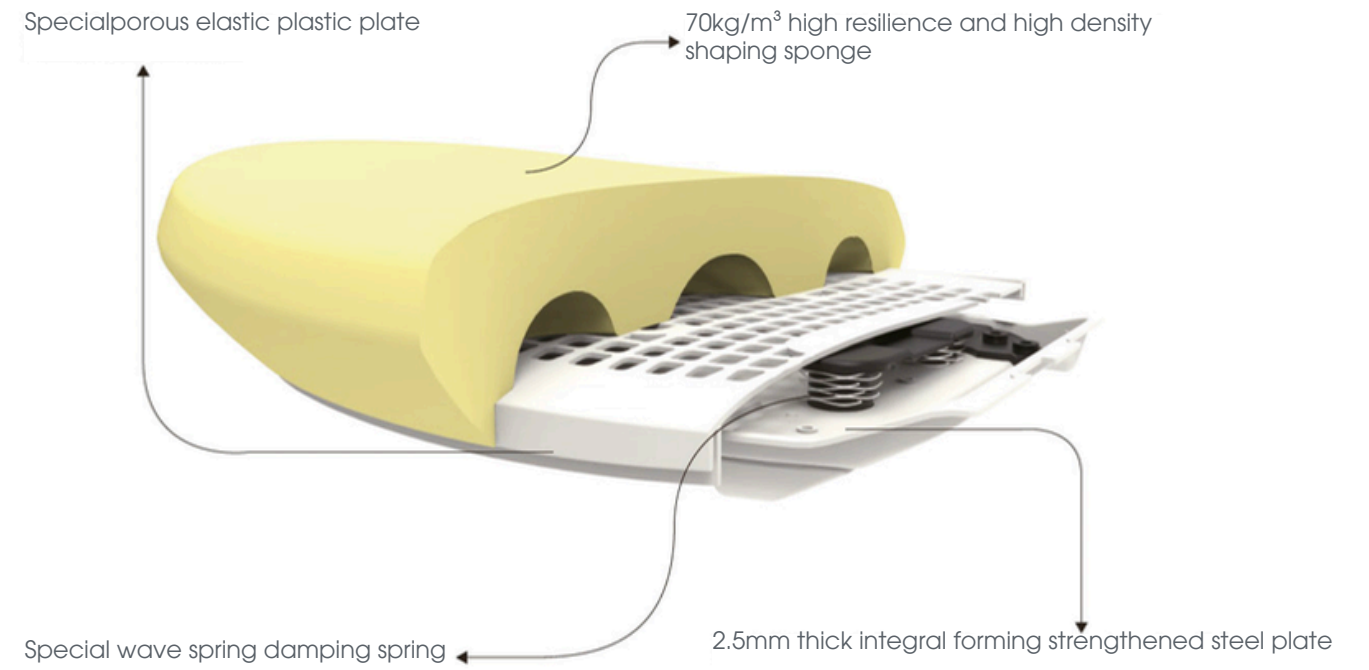

Adjust seat height and tilt tension across 20 cycles



The pitch angle is adjusted to 4 gears. Adjustment range 22 degrees



Adjust seat depth by 50mm



Adjust armrest height by 80mm



Adjust armrest depth by 45mm



Adjust armrest angle by 30mm. Angle range 20° - + 25°



# Well-B

A stylish moulded back with breathable mesh and a supportive lumbar adjustment, which allows the user to sit with optimal comfort and personalised support. Its ergonomic design promotes circulation, which can increase energy and improve productivity in the workplace.

PaperPunch



# Well-B

## Smart Support for Everyday Performance.

The Well-B chair is engineered to provide adaptable support in dynamic work environments. Its durable Wintex mesh back promotes airflow while maintaining firm, flexible support. 4D adjustable armrests and an adjustable lumbar support allow for personalised comfort throughout the day, while a supportive headrest offers added relief during extended periods of sitting.

At the core of Well-B is a weight-activated synchronised mechanism, featuring four locking positions and a seat slide, all seamlessly controlled via an intuitive wire mechanism. Whether you're leaning in or reclining back, Well-B moves with you, delivering ergonomic precision and all-day comfort.

### Guarantee

- 10-year guarantee on parts.
- 5-year guarantee on fabric.





A stylish moulded back with breathable mesh and a supportive lumbar adjustment, which allows the user to sit with optimal comfort and personalised support. Its ergonomic design promotes circulation, which can increase energy and improve productivity in the workplace.



Black

## FEATURES

- Durable wintex mesh back
- 4D adjustable armrests
- Weight-activated synchronized mechanism with 4 locking positions and seat slide all controlled by a wire mechanism
- Supportive headrest
- Adjustable lumbar support for added comfort

## DIMENSIONS

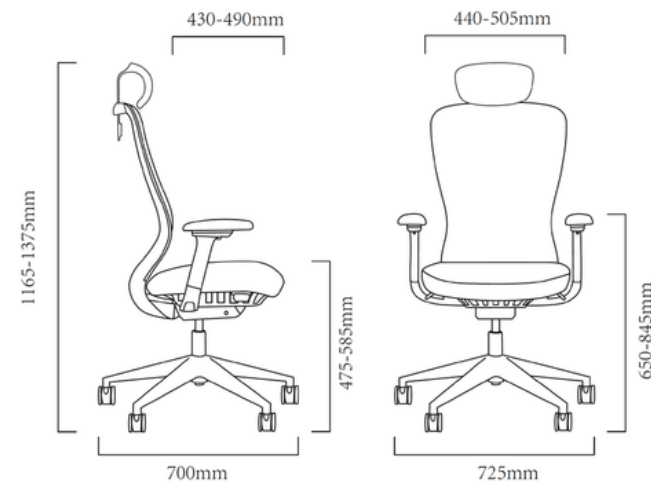



# NV

The modern ergonomic design of the NV chair makes it a great option for any office or home environment. The ergonomic backrest design ensures maximum flexibility and comfort while working at a desk.



# NV

## Ergonomic Comfort, Designed for You.

The NV chair is thoughtfully engineered for comfort and support. Its uniquely curved backrest is designed to align with the natural shape of your spine, providing lasting support for your back and neck throughout the working day. Wrapped in high-quality 3D mesh, the backrest promotes airflow to keep you cool and comfortable at your desk.

The chair's versatile design also offers complete freedom of movement. It swivels a full 360 degrees, tilts smoothly from the upright position, and features adjustable seat height and armrests, allowing you to customise your seating to the perfect working position.

### Guarantee

- 10-year guarantee on parts.
- 5-year guarantee on fabric.





The NV chair is crafted with comfort, style, and quality at its core. Available in sleek Black, Grey, or Off-White frame finishes, it also offers the option of a headrest for enhanced support.

Expanding on its versatility, the NV range features five additional seat fabric options from the premium Medley collection, giving you even more ways to personalise your perfect chair.

**Frame**



**Fabrics**

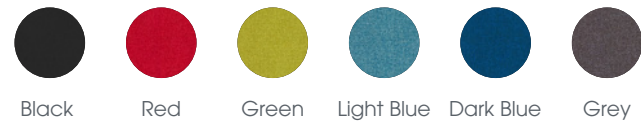

## FEATURES

- Unique Curved Backrest for Ergonomic Comfort
- Easily Adjustable Lumbar Support
- Auto Weight Balance
- Seat Slide
- Breathable 3D Mesh Backrest
- Lever Control Mechanism with Weight Balance
- Robust Star Base with Easy Glide Castors
- Changeable Seat Covers

## DIMENSIONS

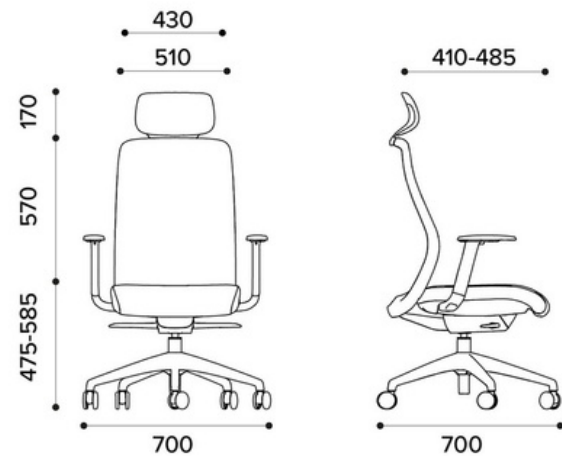



The NV chair combines modern ergonomics with timeless style, making it a versatile choice for both home and office. Its sculpted backrest adapts to your posture, providing lasting flexibility and comfort throughout the day, while its refined design reflects quality and sophistication.



### **Buy Once, Refresh Forever**

Extend your NV lifespan at any time. All chair components are available for individual purchase, allowing you to refresh and extend the chair's lifespan at any time.



### **Changeable Seat Covers**

Refresh your chair with a new colour or replace a worn cover. Designed to help extend the lifespan of your chair while giving you the flexibility to adapt to your evolving style and needs.





### **Mesh and Vinyl Options**

NV offers a breathable mesh option or a sleek, easy-to-clean vinyl option. Whether you prefer airflow and flexibility or durability and effortless maintenance, there's a material to suit your needs.



The NV Mesh is an exceptional all-mesh office chair, combining modern style with advanced ergonomic support. Its sleek, contemporary design pairs seamlessly with a range of comfort-focused features, creating a chair that looks as good as it feels.

- |   |   |
|---|---|
| <b>Frame</b>  | <b>Fabric</b>   |
|  |  |
| Black   | Black Mesh  |

## FEATURES

- Wintex Digital mesh back
- Height adjustable lumbar support
- 4D adjustable armrest with PU pad
- Wintex Digital mesh seat
- Weight-activated synchronized mechanism with 4 locking positions, with seat slide, Wire control
- Gaslift range 1108-5035J
- Seat height: 475-575mm.

## DIMENSIONS

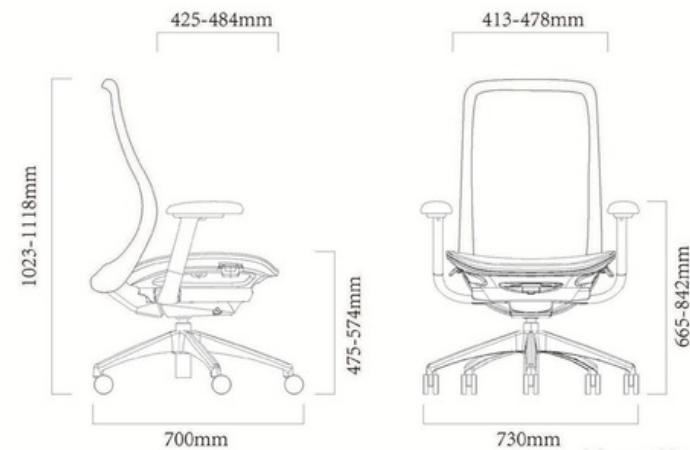



# UX

UX delivers a premium seating experience, born from the fusion of innovative design and high-quality materials. It continues Narrative Seating's story of crafting furniture that shapes how we work, feel, and connect. The engineered backrest features a flexible plastic structure that moves with your body, offering responsive, continuous support. Paired with an upholstered seat and breathable mesh backrest, UX ensures lasting comfort throughout the day.



# UX

## Designed for Performance. Built for Comfort.

The UX chair blends advanced ergonomics with refined simplicity to support focused work throughout the day. Its flexible engineered plastic backrest, paired with breathable 3D air mesh, adapts to your body's movements while promoting airflow for lasting comfort. The height-adjustable seat and precision-engineered tilt mechanism offer a range of natural motion - with a backward tilt of 0-11° and forward tilt of 0-5° - encouraging active sitting and improved posture. Equipped with a KGS Class 4 gas lift, 60mm castors, and a durable 350mm nylon base, UX delivers smooth movement and reliable support. Certified to ISO, BIFMA, and GreenGuard standards, it meets the highest benchmarks for safety, sustainability, and performance.

### Guarantee

- 10-year guarantee on parts.
- 5-year guarantee on fabric.





A premium seating experience born from the fusion of innovative design and high-quality materials. The engineered backrest features a flexible plastic structure that moves with your body, providing continuous support. The upholstered seat and breathable mesh backrest ensure comfort throughout the day.

Colour combinations (backrest/seat/frame)



## FEATURES

- Flexible engineered plastic with air mesh
- Breathable 3D mesh Height adjustable Tilt function:
- Backward tilt: 0~11° / Forward tilt: 0~5° KGS class 4
- cylinder 60mm castor & 350mm nylon base ISO,
- BIFMA, GreenGuard certified.
- 
- 

## DIMENSIONS

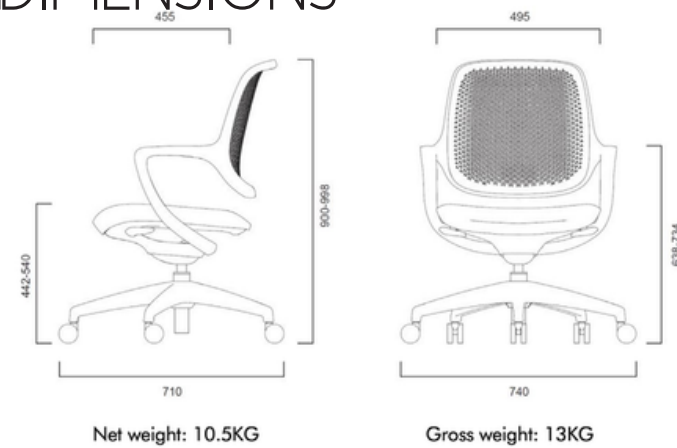

# FEATURES

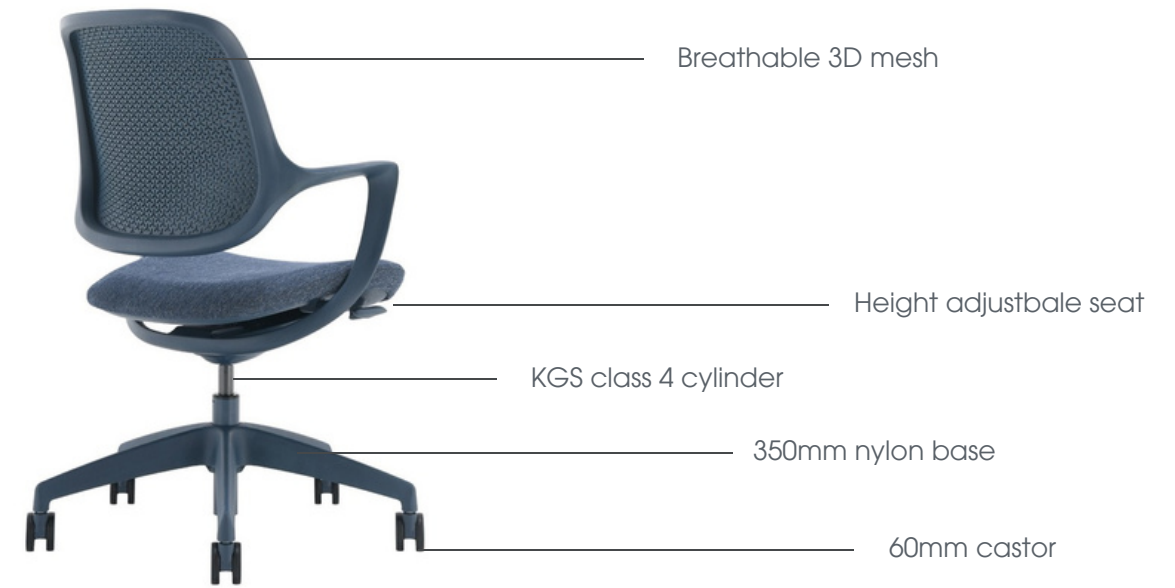

## Tilt Function

UX is equipped with a tilt function designed to support natural body movement throughout the day. The chair supports natural movement with a **backward tilt range of 0° to 11°**, for comfortable reclining and a **forward tilt range of 0° to 5°** to promote active sitting and better posture. This enhances ergonomic support, encouraging movement and flexibility for a healthier sitting experience.

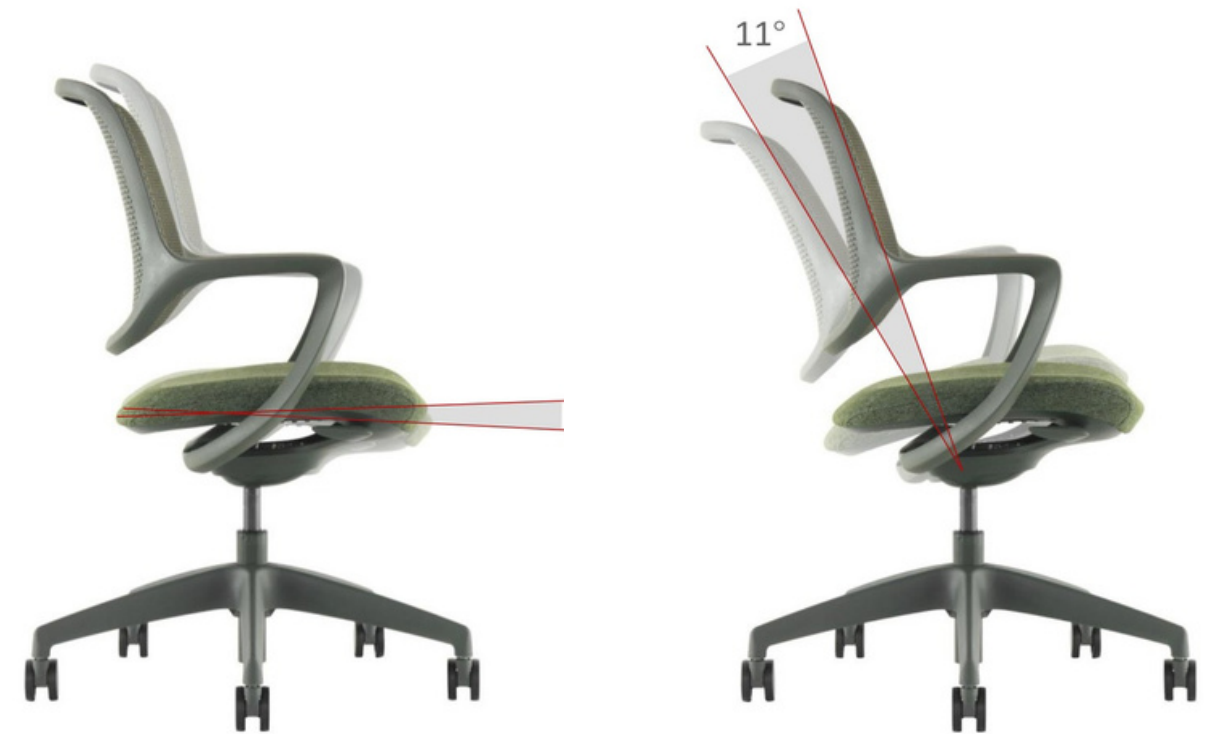

Forward tilt: 0° - 5°

Backward tilt: 0° - 11°





# Exemplar

Exemplar by Narrative Seating is an executive chair that elevates any office space with its sleek, modern design and minimalist elegance. Rooted in Narrative Seating's ethos of storytelling through design, Exemplar embodies the tale of refined leadership and everyday excellence.



# Exemplar

## Effortless Comfort, Engineered for Excellence.

Crafted with an intuitive slim-mechanism system, Exemplar chairs offer effortless, personalised adjustments, ensuring all-day ergonomic support. Whether for individual offices or premium meeting spaces, this seating solution combines superior comfort with refined style.

### Guarantee

- 10-year guarantee on parts.
- 5-year guarantee on fabric.





Experience the next level of comfort and sophistication with Exemplar premium executive seating. These chairs are designed to elevate any office environment with their sleek, modern aesthetic and minimalist elegance.



Black Microfibre Leather  
PU-40

## FEATURES

- Pneumatic height adjustment
- Seat depth adjustment
- Tilt tension control
- Back stop
- BIFMA certified

## DIMENSIONS

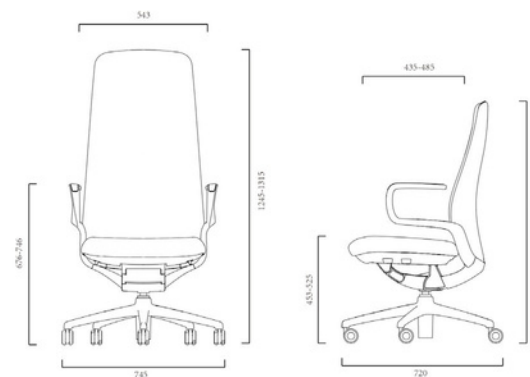

# FEATURES

## Pneumatic Height Adjustment

Pneumatic height adjustment is used to adjust the seat to fit different user heights. (1) Pull out the lever up and lift the body out of the chair to raise the seat. To lower the seat, remain seated and pull the lever up.

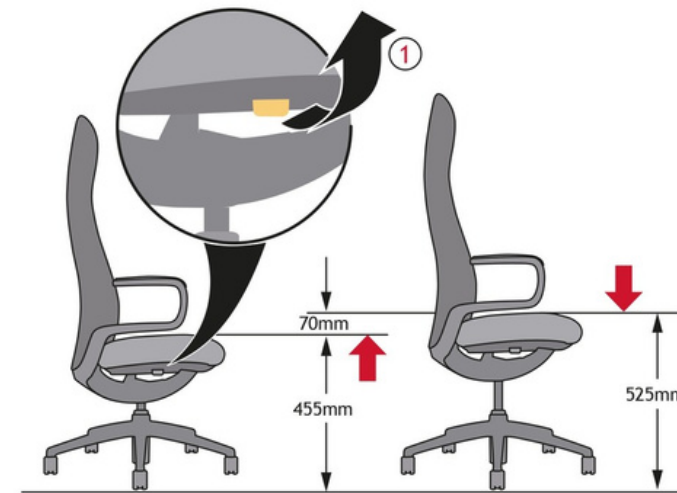

## Seat Depth Adjustment

Seat depth adjustment moves the seat pan to accommodate different leg lengths. Pull out the lever, and slide the seat pan front to back.



## Tilt Tension Control

The weight-activated synchronised mechanism adjusts tilt tension based on the user's weight. To fine-tune it, use the Allen key: align it with the adjustment hole and turn clockwise to increase tension or anticlockwise to decrease it.

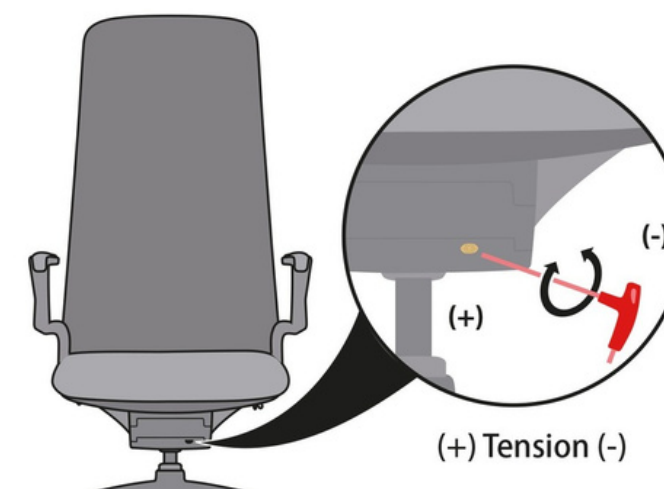

## Back Stop

Back stop allows users the choice of selecting 3 positions locking. (1) Recline to the desired stopping position and (2) pull out the lever to activate the back stop. (3) Push in the lever and recline to release the back stop.

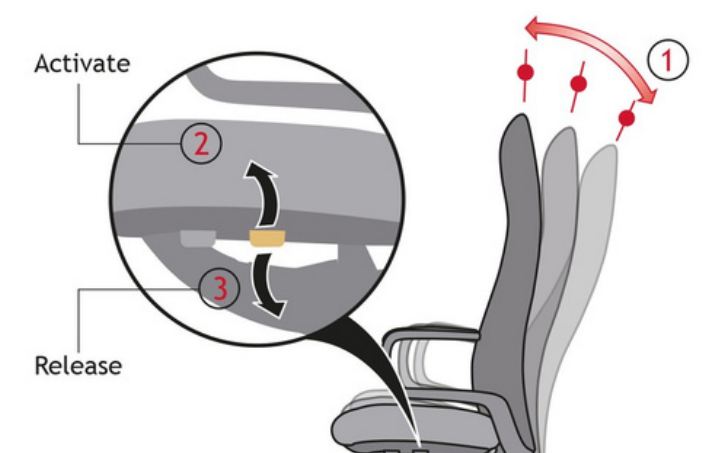





*Narrative*  
OFFICE SEATING

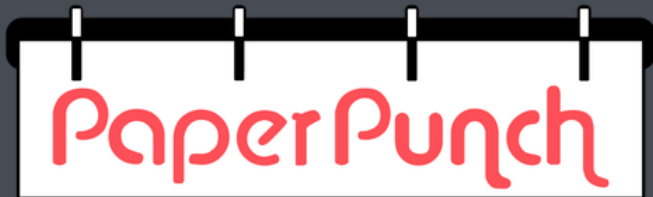

office supplies

**20 Orion Business Campus,  
Northwest Business Park,  
Ballycoolin, Dublin  
D15 DK61**

**Tel: +353 (0)1 8392232**

**EMAIL: [sales@paperpunch.ie](mailto:sales@paperpunch.ie)**

**WEB: [www.paperpunch.ie](http://www.paperpunch.ie)**